



DNH

HEAD OFFICE, NORWAY

DNH AS

Phone..... + 47 35 98 56 00

E-mail..... dnh@dnh.no

Web-Site..... www.dnh.no

ENGLAND

DNH WW Ltd

Phone..... + 44 1908 275 000

Fax..... + 44 1908 275 100

E-mail..... dnh@dnh.co.uk

GERMANY

DNH GmbH

Phone... + 49 040 6569 30-0

Fax..... + 49 040 6569 30-30

E-mail..... dnh@dnh.de

SAFE-10P(T)

USA

DNH Speakers Inc

Phone..... + 1 484 494 5790

Fax..... + 1 484 494 5793

E-mail..... dnh@dnhspeakers.com

ISO 9001 CERTIFIED

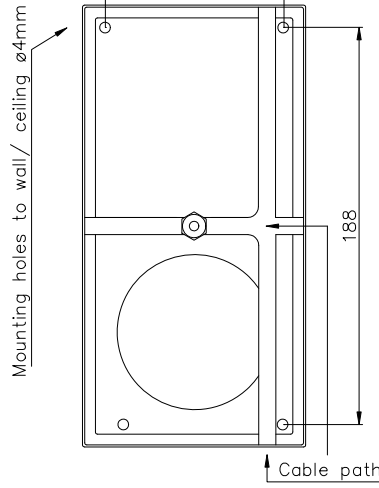
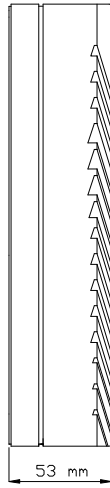
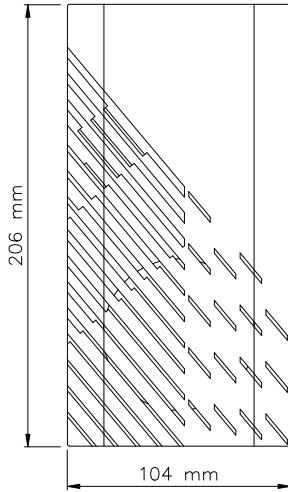
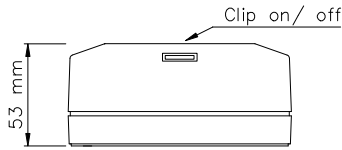

CIRCUIT DIAGRAM

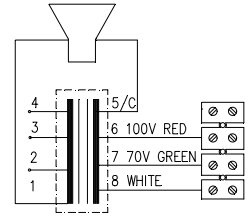

Primary connection

White:Green 70V
White:Red 100V

Secondary nominal tapings

C : 1	10,0 W
C : 2	5,0 W
C : 3	2,5 W
C : 4	1,0 W

Low impedance

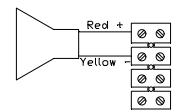

Sound pressure levels at 1W/1m

SPL vs Freq

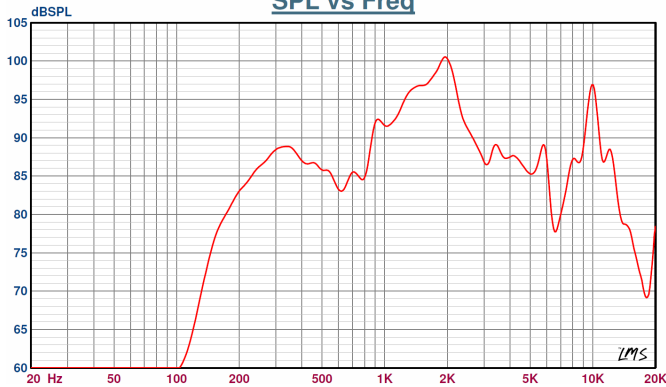

Specifications

Material / Color	ABS / RAL 9010
Mounting	4 screws
Termination	Screw terminal
Weight w/transformer	0,8 kg
IP-rating	55
Max. / min. amb. temp	90°C / -40°C
Rated power	10 W
SPL 1W/1m	87 dB
SPL rated power	97 dB
Effective freq. range	160 – 17000 Hz
Dispersion (-6dB) 1kHz / 4kHz	115° / 70°
Options	Impedances, colors, labels

Installation, Operation and Maintenance Procedures

- Open the cabinet, pressing the clip on the short end of the cabinet, and lift the cabinet from the mounting plate.
- Lead cable through the cable gland and connect to terminal 70V (white – green) or 100V (white – red).
- Choose required power on the transformer.
- Fasten the mounting plate to wall or ceiling by four screws.
- Close the cabinet by clipping on the front cover.
- For optimum performance, always use the correct voltage / power and operate within the frequency limits as stated.
- Do not open loudspeaker when energized.
- This loudspeaker is supplied with two years warranty against defective workmanship.

DNH reserves the right to alter specifications without notice.

